



I Lanterne in fusione di alluminio. Palo realizzato in fusione di alluminio anticorodal, con sportello per il collegamento elettrico alla rete. Fissaggio al suolo mediante piastra fornita di serie, da annegare in calcestruzzo (esclusi L1A, L1C, L1F).

UK Lanterns made of cast aluminium. Poles are made of cast aluminium (anticorodal) with an easy access inspection door for hook-up to main power supply. The anchoring system, which should be sunk into a concrete plinth, is included (excepted L1A, L1C, L1F).

D Laternen aus Aluminiumdruckguß. Der Mast ist aus Aluminiumdruckguß (Anticorodal) und hat ein Wartungstürchen zum elektrischen Netzanschluß. Die Bodenverankerung erfolgt durch eine serienmäßige Platte zum Eingießen in Beton (ausgenommen L1A, L1C, L1F).

Wagner

Garden Light

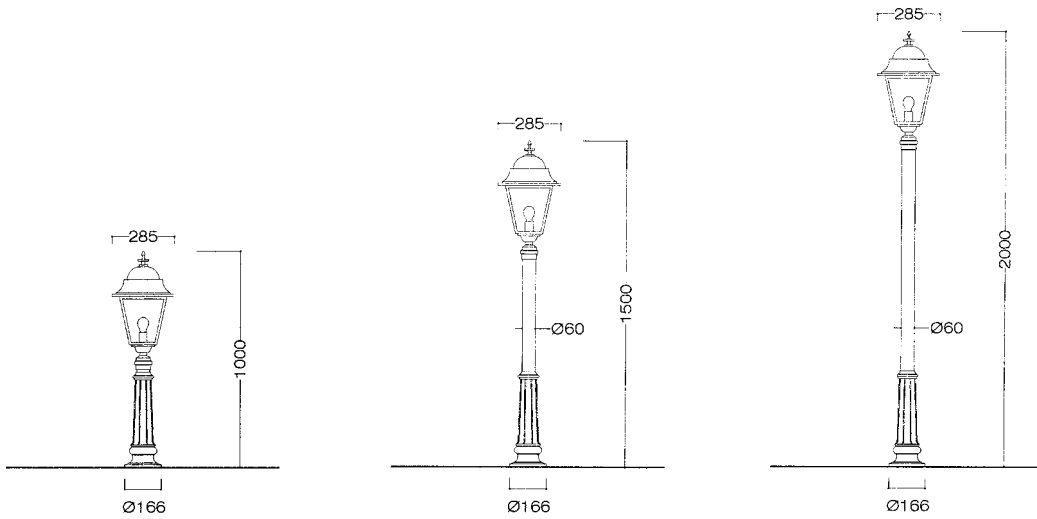

L1A ••

L1C ••

L1F ••

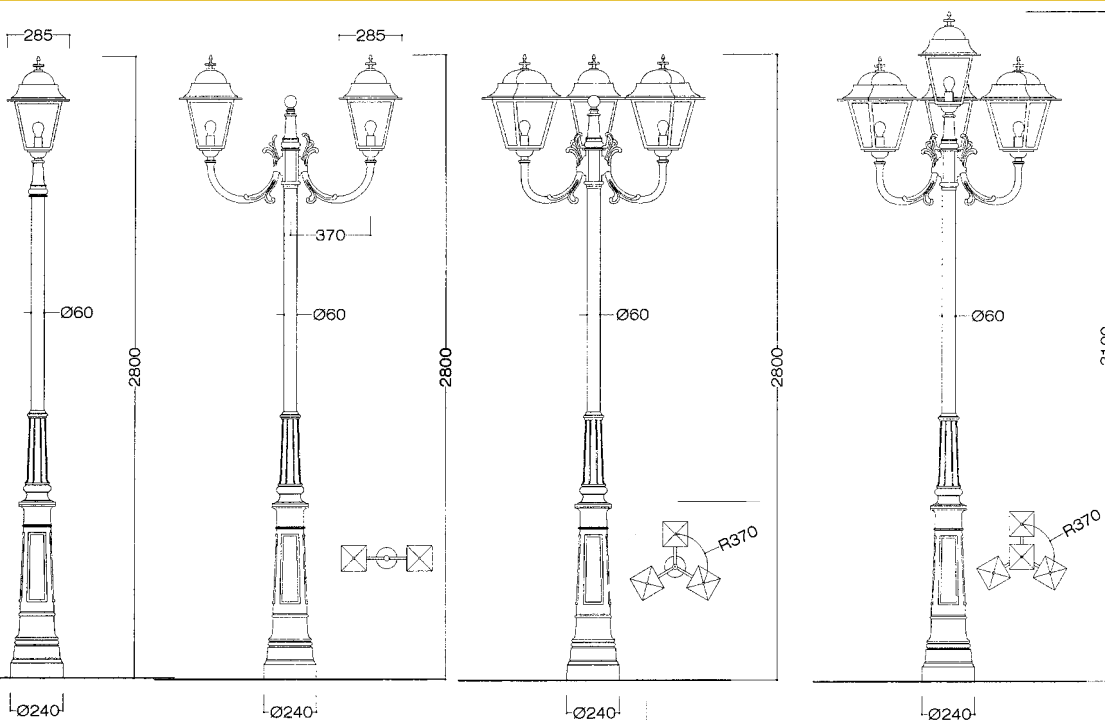

L4F ••

L1T ••

L2C ••

L2H ••



Wagner

Garden Light

I Lanterne in fusione di alluminio. Palo di acciaio zincato e verniciato. Fissaggio al suolo per interramento.

UK Lanterns made of cast aluminium. Painted, zinc-galvanized steel pole. Anchoring is done by sinking pole into the ground.

D Laternen aus Aluminiumdruckguß. Der Mast ist aus verzinktem lackiertem stahl. Die Bodenverankerung erfolgt durch Masteingrabung.

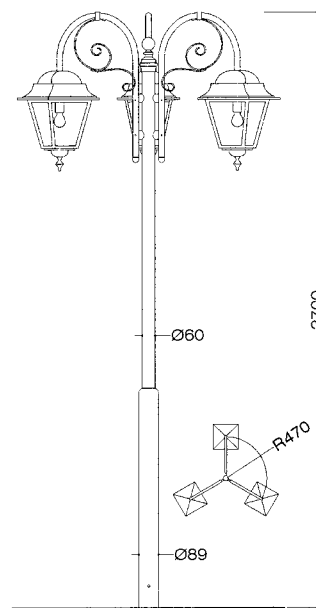
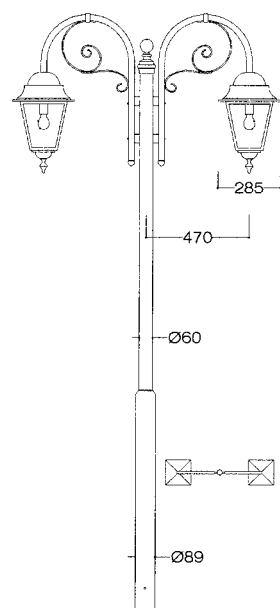
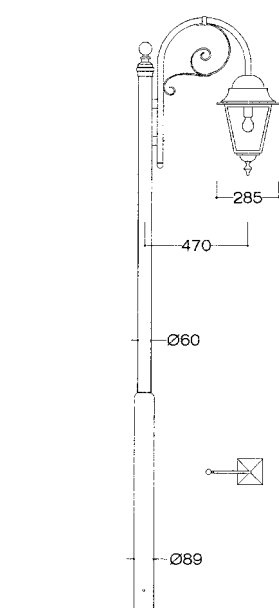
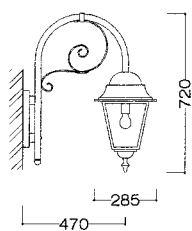

179 ••

LFR ••

LFS ••

LFT ••

Class I



IP23

E27

100W GLS

--- B • White

--- N • Black

--- S • Sanded Glass

--- X • Clear Glass

thus
ITALIA

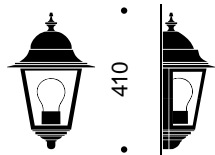

• 235 • • 150 •

IP23 E27 100W

105 ••

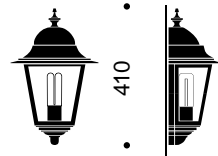

• 235 • • 150 •

IP23 G24-d2 18W

106 ••

I Lanterne in fusione di alluminio, disponibili in due diverse dimensioni.

UK Lanterns made of cast aluminium, available in two sizes and in a variety of applications.

D Laternen aus Aluminiumdruckguß in drei Größen verfügbar.

Class I



- B • White
- N • Black
- • S Sanded Glass
- • X Clear Glass

K

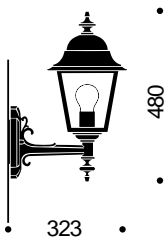

IP23 E27 100W

013 ••

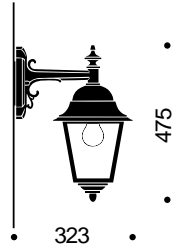

IP23 E27 100W

014 ••

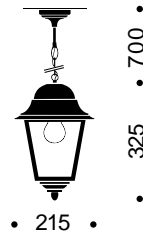

IP20 E27 100W

015 ••

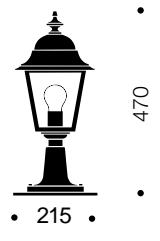

IP23 E27 100W

196 ••

L

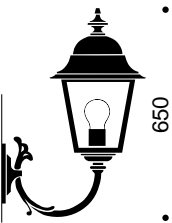

IP23 E27 100W

070 ••

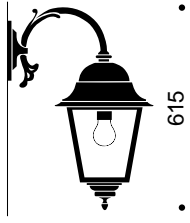

IP23 E27 100W

071 ••

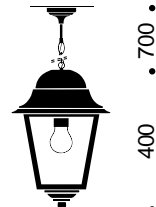

IP20 E27 100W

072 ••



IP23 E27 100W

197 ••

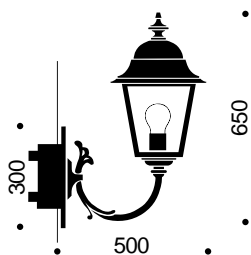

IP23 E27 100W

081 ••

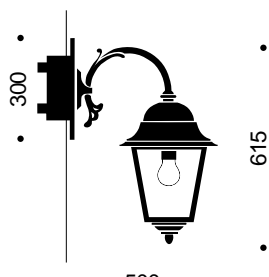

IP23 E27 100W

084 ••



IP23 E27 100W

179 ••